



OPTIBELT PRODUCT RANGE

A blue circular icon containing a white lowercase letter 'i', representing information.

OVERVIEW OF ALL PRODUCTS

INCLUDING PULLEYS AND BUSHES



HIGH-TECH MACHINERY REQUIRES HIGH-TECH DRIVE TECHNOLOGY.

Since 1948 the Optibelt company has been manufacturing a wide variety of drive belts, drawing on more than a century of experience of working with rubber.

Constant investment in materials research and production technology as well as growing knowledge about the constraints associated with various uses have pushed the boundaries of machine capacity to new limits thanks to further development of the belt into a high-tech drive system.

Page 8

optibelt RED POWER 3
optibelt RED POWER 3 Classic

Page 9

optibelt BLUE POWER

Page 10

optibelt SK
optibelt VB

Page 11

optibelt KB RED POWER 3
optibelt KB RED POWER 3 Classic

Page 12

optibelt KB BLUE POWER

Page 13

optibelt KB/SK
optibelt KB/VB

Page 14

optibelt PKR/PKB

POWER TRANSMISSION
V-BELTS AND
KRAFTBANDS

Page 16

optibelt SUPER E-POWER
optibelt SUPER X-POWER

Page 17

optibelt SUPER TX
optibelt SUPER KBX-POWER

Page 18

optibelt KBX
optibelt VARIO POWER

POWER TRANSMISSION
RAW EDGE
V-BELTS AND
KRAFTBANDS

Page 20

optibelt OMEGA HP
optibelt OMEGA HL

Page 21

optibelt OMEGA
optibelt OMEGA FAN POWER

Page 22

optibelt HTD
optibelt STD

Page 23

optibelt ZR
optibelt OMEGA Double-sided

Page 24

optibelt HTD Double-sided
optibelt STD Double-sided
optibelt ZR Double-sided

Page 25

optibelt OMEGA HP LINEAR
optibelt OMEGA LINEAR

Page 26

optibelt HTD LINEAR
optibelt ZR LINEAR

POWER TRANSMISSION
CHLOROPRENE
TIMING BELTS

Page 34

optibelt DELTA CHAIN Carbon
optibelt ALPHA POWER

Page 35

optibelt ALPHA TORQUE

Page 36

optibelt ALPHA FLEX
optibelt ALPHA LINEAR / V

Page 37

optibelt ALPHA SPECIAL

Page 39

optibelt ALPHA SRP

Page 40

optibelt ALPHA ZS/ZSI
optibelt ALPHA PINJOIN

MATERIAL HANDLING
POLYURETHANE
TIMING BELTS



OPTIBELT PRODUCT WORLD

Page 42

optibelt MARATHON 1
optibelt RBK

Page 43

optibelt ZRK
optibelt KIT

Page 44

optibelt TRUCK POWER MARATHON 2
optibelt TRUCK POWER RBK

Page 45

optibelt TRUCK POWER KBX
optibelt TRUCK POWER KIT

SERVICE TOOLS

Page 46

optibelt TT-A
optibelt MT-A/MT-A II

Page 47

optibelt OPTIKRIK 0, I, II, III
optibelt MEASURING GAUGE
optibelt LASER POINTER II

AUTOMOTIVE TECHNOLOGY
DRIVE BELTS FOR
MOTOR VEHICLES

Page 50

optibelt RB

Page 51

optibelt DK
optibelt RR/RR Plus/KK

Page 52

optibelt OPTIMAT OE/DK/FK
optibelt OPTIMAT PKR

POWER TRANSMISSION
BELTS FOR SPECIAL
DRIVE SOLUTIONS

Page 54

optibelt ELASTOMIT
TECHNICAL
ELASTOMER SHEETING
optibelt ELASTOMIT
X-RAY PROTECTION

Page 55

FITNESS AND
THERAPY BANDS

ELASTOMER SOLUTIONS
TECHNICAL
ELASTOMER FOILS

Page 58

optibelt KS
optibelt ZRS

Page 59

optibelt ZRS DC
optibelt RBS

Page 60

optibelt SPECIAL PULLEYS

Page 60

optibelt METAL ACCESSORIES

Page 61

optibelt TB
optibelt CE

PULLEYS AND
BUSHES



Page 29–32
OVERVIEW OF
OUR PRODUCTS



From Page 64
SERVICE TOOLS
PROFESSIONAL TOOLS FOR
INSTALLATION AND MAINTENANCE

OPTIBELT POWER TRANSMISSION

Optibelt offers the highest technological quality in the form of customized drive solutions and industry specific products. More than 10,000 of these can be delivered to anywhere in the world within 24 hours.

From extremely large to extremely small: Optibelt supplies V-belts, timing belts, ribbed belts, kraftbands and tailored products for every application, whether in oil production facilities, fans or sewing machines.

We have the right solution for every application, such as our **optibelt RED POWER 3** V-belts with best quality, guaranteed reliability and maintenance-free operation.

To keep your machinery running when it needs to.



Page 8

optibelt RED POWER 3 HIGH PERFORMANCE WEDGE BELTS
optibelt RED POWER 3 Classic HIGH PERFORMANCE V-BELTS

Page 9

optibelt BLUE POWER HIGH PERFORMANCE WEDGE BELTS

Page 10

optibelt SK HIGH PERFORMANCE WEDGE BELTS
optibelt VB CLASSIC V-BELTS

Page 11

optibelt KB RED POWER 3 HIGH PERFORMANCE KRAFTBANDS
optibelt KB RED POWER 3 Classic HIGH PERFORMANCE KRAFTBANDS

Page 12

optibelt KB BLUE POWER HIGH PERFORMANCE KRAFTBANDS

Page 13

optibelt KB/SK KRAFTBANDS
optibelt KB/VB KRAFTBANDS WITH CLASSIC V-BELTS

Page 14

optibelt PKR/PKB V-BELTS AND KRAFTBANDS

“Maintenance-free.”

Norbert, 42, Foreman

V-BELTS AND KRAFTBANDS



maintenance-free

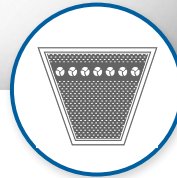

optibelt RED POWER 3 S=C Plus

HIGH PERFORMANCE WEDGE BELTS

maintenance-free in accordance with DIN 7753 Part 1, ISO 4184 and RMA/MPTA

DIMENSIONS

SPZ	1202–3550 mm
SPA	1207–4000 mm
SPB	1250–8000 mm
SPC	2000–10 000 mm
3V / 9N	47.5–140 inches
5V / 15N	53–315 inches
8V / 25N	100–475 inches

Further sizes upon request

V-GROOVED PULLEYS

all standard pulleys, special pulleys on request

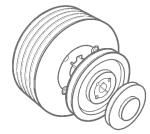

maintenance-free



optibelt RED POWER 3 Classic S=C Plus

HIGH PERFORMANCE V-BELTS

maintenance-free in accordance with DIN 2215 / ISO 4184, available on request

DIMENSIONS

A / 13	1320–4000 mm
B / 17	1320–4000 mm

Further sizes upon request

V-GROOVED PULLEYS

all standard pulleys, special pulleys on request

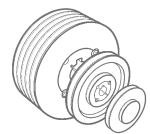



OPTIBELT SUCCESS STORY

**METSO MINERALS –
BEST BELT FOUND**

Metso Minerals produces systems and machinery in 50 production facilities around the world and has sales centres in more than 100 countries.

“**optibelt RED POWER 3** products,” says Tero Majuri, development engineer at Metso Minerals, “are the first choice when it comes to finding the right belt.” Since breaking up and crushing calls for powerful drives then equally high-quality belts are needed too. “We have found the RED POWER 3 from Optibelt to be the best belts for our new generation of impact and jaw crushers.”



optibelt BLUE POWER

HIGH PERFORMANCE WEDGE BELTS

with aramid cord
DIN 7753 Part 1, ISO 4184 and RMA/MPTA

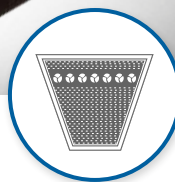

DIMENSIONS	
SPB	1500–8000 mm
SPC	2000–9000 mm
8V / 25N	160–355 inches
Further sizes upon request	

V-GROOVED PULLEYS
all standard pulleys,
special pulleys on request

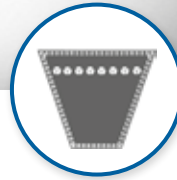

optibelt **SK** S=C Plus

HIGH PERFORMANCE WEDGE BELTS
DIN 7753 Part 1, ISO 4184 and RMA/MPTA

DIMENSIONS	
SPZ	487–3550 mm
SPA	732–4500 mm
SPB	1250–8000 mm
SPC	2000–12 500 mm
3V/9N	25–140 inches
5V/15N	53–355 inches
8V/25N	100–500 inches
Further sizes upon request	

V-GROOVED PULLEYS
all standard pulleys,
special pulleys on request



optibelt **VB** S=C Plus

CLASSIC V-BELTS
DIN 2215/ISO 4184

DIMENSIONS	
5	200–610 mm
Y/6	295–865 mm
8	335–1270 mm
Z/10	312–2522 mm
A/13	437–5030 mm
B/17	610–7140 mm
20	950–6050 mm
C/22	1148–8058 mm
25	1460–9060 mm
D/32	2075–11 275 mm
E/40	3080–12 580 mm
Further sizes upon request	

V-GROOVED PULLEYS
all standard pulleys,
special pulleys on request



maintenance-free

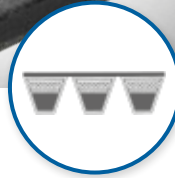

optibelt **KB RED POWER 3**

HIGH PERFORMANCE KRAFTBANDS
maintenance-free

DIMENSIONS	
SPB	2000–8000 mm
SPC	3000–10000 mm
3V / 9J	50–140 inches
5V / 15J	56–315 inches
8V / 25J	100–475 inches

KRAFTBAND PULLEYS
all standard pulleys,
special pulleys on request



maintenance-free

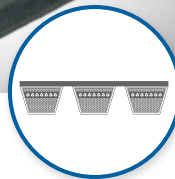

optibelt **KB RED POWER 3 Classic**

HIGH PERFORMANCE KRAFTBANDS
maintenance-free

DIMENSIONS	
B	1320–4000 mm
Further sizes upon request	

KRAFTBAND PULLEYS
all standard pulleys,
special pulleys on request





optibelt KB BLUE POWER

HIGH PERFORMANCE KRAFTBANDS

with aramid cord

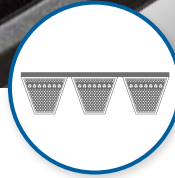

DIMENSIONS

SPB	2000–8000 mm
SPC	3000–10 000 mm
5V / 15J	80–315 inches
8V / 25J	100–475 inches

KRAFTBAND PULLEYS

all standard pulleys,
special pulleys on request

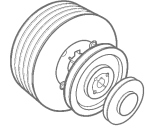

OPTIBELT SUCCESS STORY

AUSTRALIAN ORE MINE OPERATOR TRUSTS GERMAN QUALITY

The belts in the circulation pumps in a remote iron ore mine in Australia needed to be replaced every 8-10 weeks, generating enormous downtime.

After a general refurbishment and the installation of **optibelt BLUE POWER** high performance V-belts the number of belts and pulleys could be reduced from 14 to 8. Material cost savings and a significant reduction of downtime generated higher profitability for the ore mine.

The installed Optibelt V-belts have been running now for approximately 23 weeks without any maintenance and without any downtime.



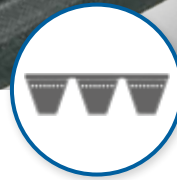

optibelt **KB/SK**

KRAFTBANDS

DIMENSIONS	
SPZ	1250–3550 mm
SPA	1250–4500 mm
SPB	2000–8000 mm
SPC	3000–12 500 mm
3V/9J	50–140 inches
5V/15J	56–355 inches
8V/25J	100–475 inches

KRAFTBAND PULLEYS
all standard pulleys,
special pulleys on request

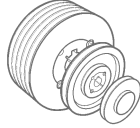
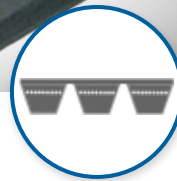



optibelt **KB/VB**

KRAFTBANDS WITH CLASSIC V-BELTS

DIMENSIONS	
A/HA	1200–4750 mm
B/HB	1200–5600 mm
C/HC	2286–6300 mm
D/HD	2500–17 780 mm

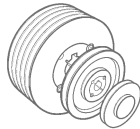
KRAFTBAND PULLEYS
all standard pulleys,
special pulleys on request



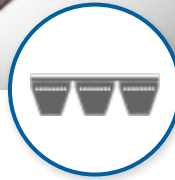
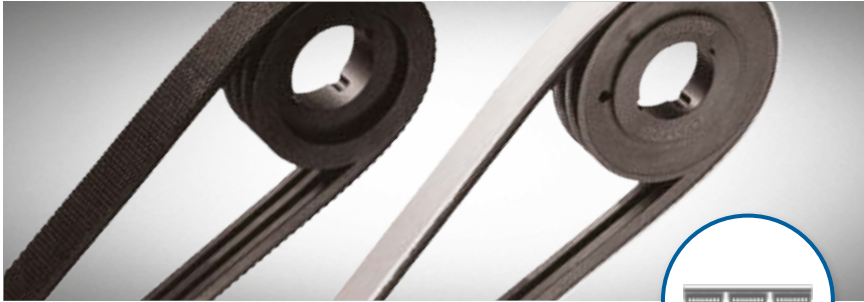

optibelt **PKR/PKB**

V-BELTS AND KRAFTBANDS WITH TOP SURFACES

VERSIONS

- Top surfaces with various shore hardnesses
- Top surfaces in various colours
- Top surfaces for various temperature ranges
- Application-specific top surfaces



PKR 0

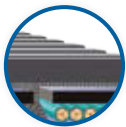

PKR 1

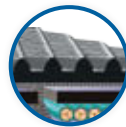

PKR 2



PKR 3

DIMENSIONS

Sections and dimensions available on request

KRAFTBAND PULLEYS

all standard pulleys, special pulleys on request

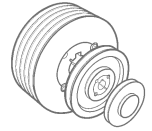

optibelt **V-BELTS** Customized solutions

WEDGE BELTS

DIMENSIONS

Sections and dimensions available on request

V-GROOVED PULLEYS

all standard pulleys, special pulleys on request

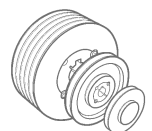

Page 16

optibelt SUPER E-POWER HIGH PERFORMANCE WEDGE BELTS

optibelt SUPER X-POWER HIGH PERFORMANCE WEDGE BELTS

Page 17

optibelt SUPER TX CLASSIC V-BELTS

optibelt SUPER KBX-POWER HIGH PERFORMANCE KRAFTBANDS

Page 18

optibelt KBX KRAFTBANDS

optibelt VARIO POWER VARIABLE SPEED BELTS

RAW EDGE V-BELTS AND KRAFTBANDS



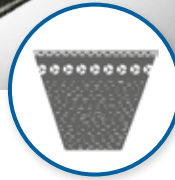
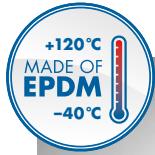

DIMENSIONS	
XPZ	587–3550 mm
XPA	707–3550 mm
XPB	1250–3550 mm
XPC	2000–3550 mm
3VX/9NX	25–140 inches
5VX/15NX	50–140 inches

optibelt SUPER E-POWER M=S

HIGH PERFORMANCE WEDGE BELTS

raw edge, moulded cogged

in accordance with DIN 7753 Part 1, ISO 4184 and RMA/MPTA

V-GROOVED PULLEYS
all standard pulleys,
special pulleys on request

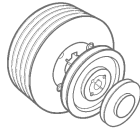
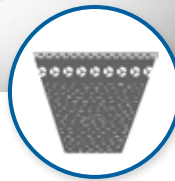
DIMENSIONS	
XPZ	587–3550 mm
XPA	707–3550 mm
XPB	1250–3550 mm
XPC	2000–3550 mm
3VX/9NX	25–140 inches
5VX/15NX	50–140 inches

optibelt SUPER X-POWER M=S

HIGH PERFORMANCE WEDGE BELTS

raw edge, moulded cogged

in accordance with DIN 7753 Part 1, ISO 4184 and RMA/MPTA

V-GROOVED PULLEYS
all standard pulleys,
special pulleys on request

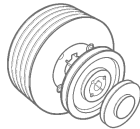



optibelt **SUPER TX M=S**

CLASSIC V-BELTS

raw edge, moulded cogged
in accordance with DIN 2215 and ISO 4184



DIMENSIONS	
ZX/X10	597–1522 mm
AX/X13	605–3380 mm
BX/X17	610–3390 mm
CX/X22	1058–3408 mm

V-GROOVED PULLEYS

all standard pulleys,
special pulleys on request

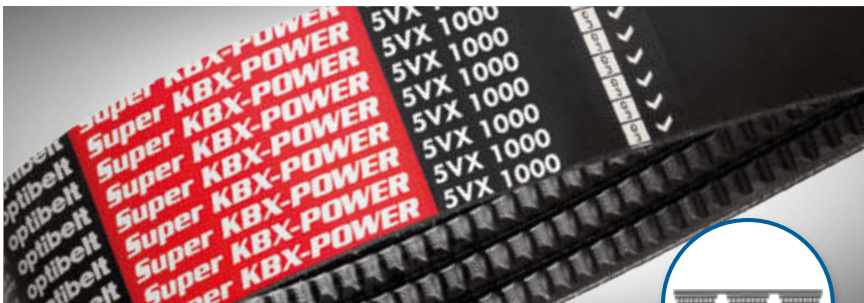
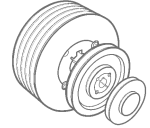

optibelt **SUPER KBX-POWER**

HIGH PERFORMANCE KRAFTBANDS

raw edge, moulded cogged



DIMENSIONS	
XPZ	on request
XPA	on request
XPB	on request
3VX/9JX	50–140 inches
5VX/15JX	50–140 inches

KRAFTBAND PULLEYS

all standard pulleys,
special pulleys on request

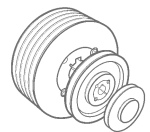

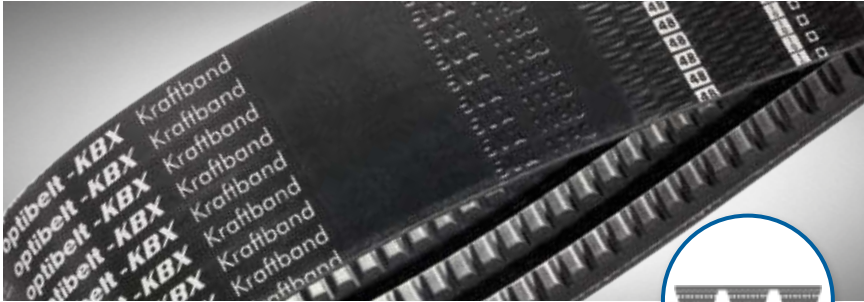

optibelt **KBX**

KRAFTBANDS

raw edge, moulded cogged

DIMENSIONS

Sections and dimensions available on request

KRAFTBAND PULLEYS

all standard pulleys, special pulleys on request

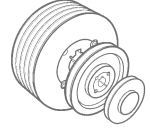

optibelt **VARIO POWER**

VARIABLE SPEED BELTS

raw edge, moulded cogged,
standard dimensions as defined in DIN/ISO and RMA/MPTA

Also available as double-sided belts

DIMENSIONS

13 x 5 – 70 x 18	468 – 2500 mm
1422 V – 4436 V	235 – 750 inches

V-GROOVED PULLEYS

all standard pulleys, special pulleys on request

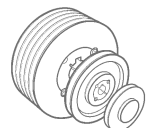

Page 20

optibelt OMEGA HP HIGH PERFORMANCE TIMING BELTS

optibelt OMEGA HL HIGH PERFORMANCE TIMING BELTS

Page 21

optibelt OMEGA TIMING BELTS

optibelt OMEGA FAN POWER HIGH PERFORMANCE TIMING BELTS

Page 22

optibelt HTD TIMING BELTS

optibelt STD TIMING BELTS

Page 23

optibelt ZR TIMING BELTS

optibelt OMEGA DOUBLE-SIDED TIMING BELTS

Page 24

optibelt HTD DOUBLE-SIDED TIMING BELTS

optibelt STD DOUBLE-SIDED TIMING BELTS

optibelt ZR DOUBLE-SIDED TIMING BELTS

Page 25

optibelt OMEGA HP LINEAR OPEN-ENDED HIGH PERFORMANCE TIMING BELTS

optibelt OMEGA LINEAR OPEN-ENDED TIMING BELTS

Page 26

optibelt HTD LINEAR OPEN-ENDED TIMING BELTS

ZR LINEAR OPEN-ENDED TIMING BELTS

CHLOROPRENE TIMING BELTS



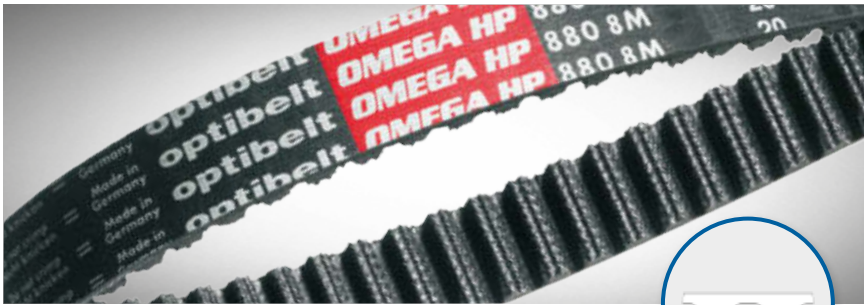

optibelt OMEGA HP

HIGH PERFORMANCE TIMING BELTS
maintenance-free

Also available as EPDM timing belts

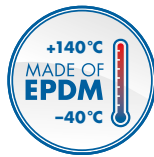

DIMENSIONS	
3M HP	111–1569 mm
5M HP	180–2525 mm
8M HP	288–3280 mm
14M HP	966–4578 mm

TIMING BELT PULLEYS

optibelt OMEGA

timing belts run in standard HTD and RPP pulleys

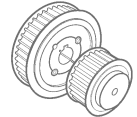

HTD/RPP



optibelt OMEGA HL

HIGH PERFORMANCE TIMING BELTS
maintenance-free, with fibreglass cords



DIMENSIONS	
8M HL	288–3280 mm
14M HL	966–2800 mm

TIMING BELT PULLEYS

optibelt OMEGA

timing belts run in standard HTD and RPP pulleys

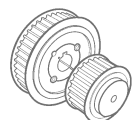

HTD/RPP

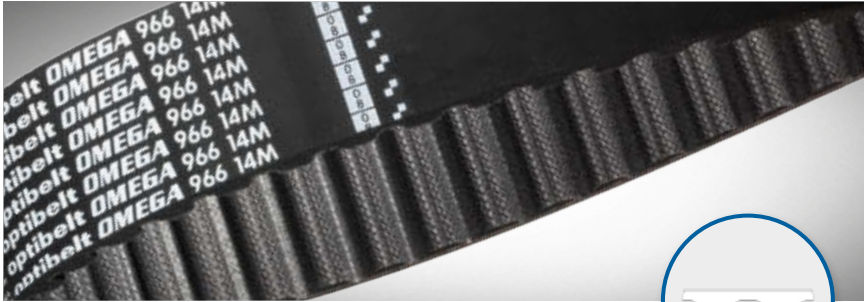

optibelt OMEGA

TIMING BELTS

powerful and universal
maintenance-free

DIMENSIONS	
2M	74 – 1224 mm
3M	111 – 1863 mm
5M	120 – 2525 mm
8M	288 – 4400 mm
14M	966 – 4578 mm

TIMING BELT PULLEYS
optibelt OMEGA



timing belts run in
standard HTD and RPP pulleys



HTD / RPP



optibelt OMEGA FAN POWER

HIGH PERFORMANCE TIMING BELTS

for ventilation operations,
anti-static, maintenance-free

Also available as EPDM timing belts

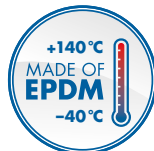

DIMENSIONS	
8M FP	2000 – 2800 mm
14M FP	3150 – 4578 mm
Further sizes upon request	

TIMING BELT PULLEYS
optibelt OMEGA

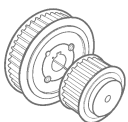

timing belts run in
standard HTD and RPP pulleys



HTD / RPP

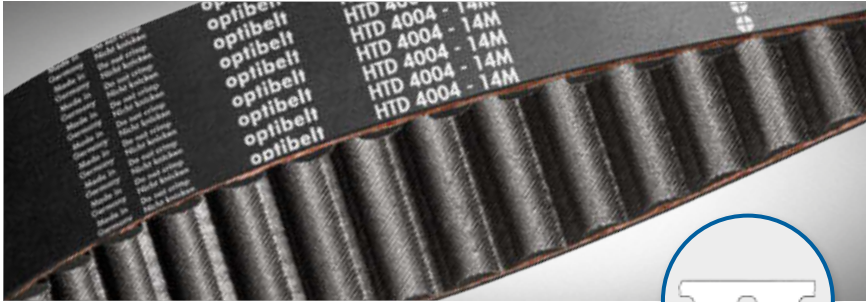

optibelt HTD

TIMING BELTS
maintenance-free



DIMENSIONS	
20M	2000–6600 mm

TIMING BELT PULLEYS
optibelt ZRS
standard timing belt pulleys HTD

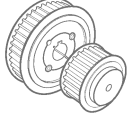
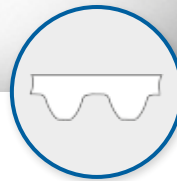
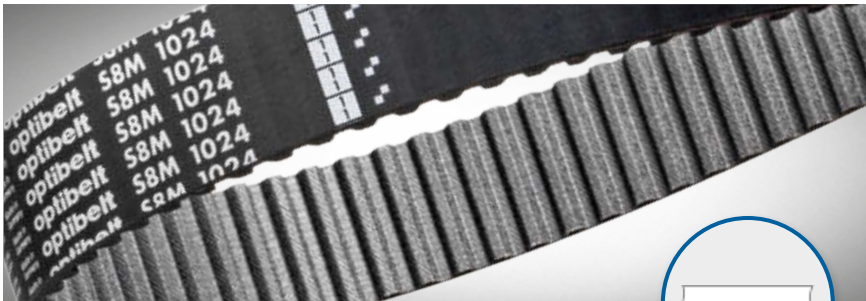
optibelt STD

TIMING BELTS
maintenance-free



DIMENSIONS	
S3M	120–633 mm
S5M	255–2000 mm
S8M	440–3200 mm
S14M	1400–5012 mm

optibelt STD also available
in HP or HL quality

TIMING BELT PULLEYS
optibelt ZRS
standard timing belt pulleys STD

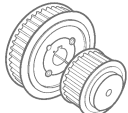

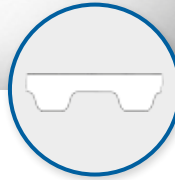

optibelt ZR

TIMING BELTS

classic profile, maintenance-free

DIMENSIONS

MXL	91.44–1026.16 mm
XL	152.40–1600.20 mm
L	276.23–1676.40 mm
H	584.20–4318.00 mm
XH	1289.05–4445.00 mm
XXH	1778.00–4572.00 mm

TIMING BELT PULLEYS

optibelt ZRS

standard timing belt pulleys

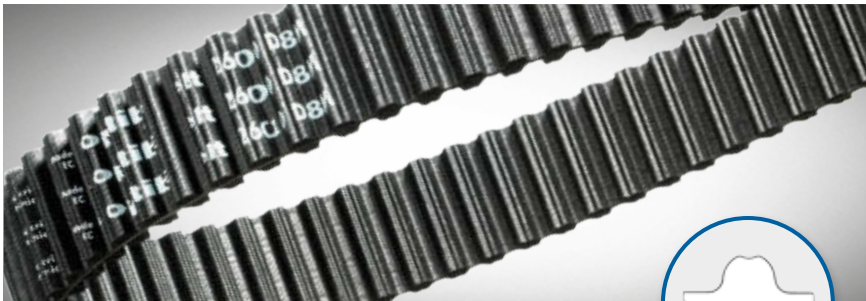
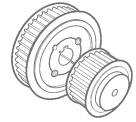

optibelt OMEGA Double-sided

TIMING BELTS

double-sided, maintenance-free

DIMENSIONS

D2M	on request
D3M	on request
D5M	1000–2525 mm
D8M	1000–3280 mm
D14M	on request

Further sizes upon request

TIMING BELT PULLEYS

optibelt OMEGA

timing belts run in standard HTD and RPP pulleys

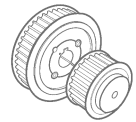

HTD/RPP

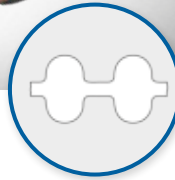
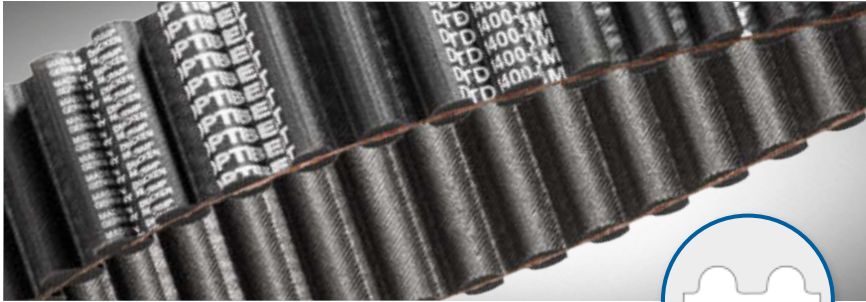

optibelt **HTD** and **STD** Double-sided

TIMING BELTS

double-sided, maintenance-free



DIMENSIONS	
D5M	565–1200 mm
D8M	600–2800 mm
D14M	966–2310 mm
DS8M	1160–1776 mm

TIMING BELT PULLEYS

optibelt ZRS

standard timing belt pulleys

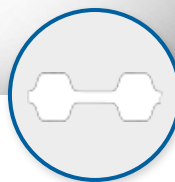
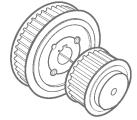

optibelt **ZR** Double-sided

TIMING BELTS

double-sided, classic profile, maintenance-free



DIMENSIONS	
DXL	381–787 mm
DL	476–1524 mm
DH	609–4318 mm

TIMING BELT PULLEYS

optibelt ZRS

standard timing belt pulleys

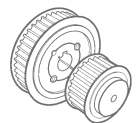



optibelt
OMEGA HP LINEAR

OPEN-ENDED HIGH PERFORMANCE TIMING BELTS
maintenance-free

DIMENSIONS	
3M HP	6–15 mm
5M HP	10–25 mm
8M HP	10–30 mm
Standard roll length 30 m	

TIMING BELT PULLEYS
optibelt OMEGA
timing belts run in
standard HTD and RPP pulleys



HTD/RPP



optibelt
OMEGA LINEAR

OPEN-ENDED TIMING BELTS
maintenance-free

DIMENSIONS	
3M	9 mm
5M	10–25 mm
8M	10–30 mm

TIMING BELT PULLEYS
optibelt OMEGA
timing belts run in
standard HTD and RPP pulleys

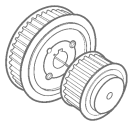

HTD/RPP



optibelt HTD LINEAR

OPEN-ENDED TIMING BELTS
maintenance-free



DIMENSIONS	
FIBREGLASS TENSION CORD	
3M	6–15 mm
FIBREGLASS OR STEEL TENSION CORD	
5M	6–25 mm
8M	10–85 mm
14M	25–85 mm
Standard roll length 30 m	

TIMING BELT PULLEYS
optibelt ZRS
standard timing belt pulleys HTD

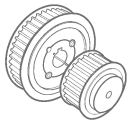



optibelt ZR LINEAR

OPEN-ENDED TIMING BELTS
classic profile, maintenance-free

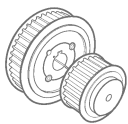

DIMENSIONS	
FIBREGLASS TENSION CORD	
MXL	6.35 mm
FIBREGLASS OR STEEL TENSION CORD	
XL	6.35–12.70 mm
L	9.53–25.40 mm
H	12.70–50.80 mm
Standard roll length 30 m	

TIMING BELT PULLEYS
optibelt ZRS
standard timing belt pulleys



Page 34

optibelt DELTA CHAIN Carbon HIGH PERFORMANCE TIMING BELTS

optibelt ALPHA POWER TIMING BELTS

Page 35

optibelt ALPHA TORQUE TIMING BELTS

Page 36

optibelt ALPHA FLEX TIMING BELTS

optibelt ALPHA LINEAR/V TIMING BELTS BY THE METRE

Page 37

optibelt ALPHA SPECIAL TIMING BELTS

Page 39

optibelt ALPHA SRP TIMING BELTS

Page 40

optibelt ALPHA ZS/ZSI TIMING BELT LOCK

optibelt ALPHA PINJOIN TIMING BELT LOCK

“It’s a matter
of trust.”

Paul, 46, Chief Engineer

POLYURETHANE TIMING BELTS

4



OPTIBELT

OVERVIEW PRODUCT RANGE

“Maintenance-free.”

Norbert, 42, Foreman

“So your car purrs like a kitten.”

Michael, 33, Mechatronics Technician

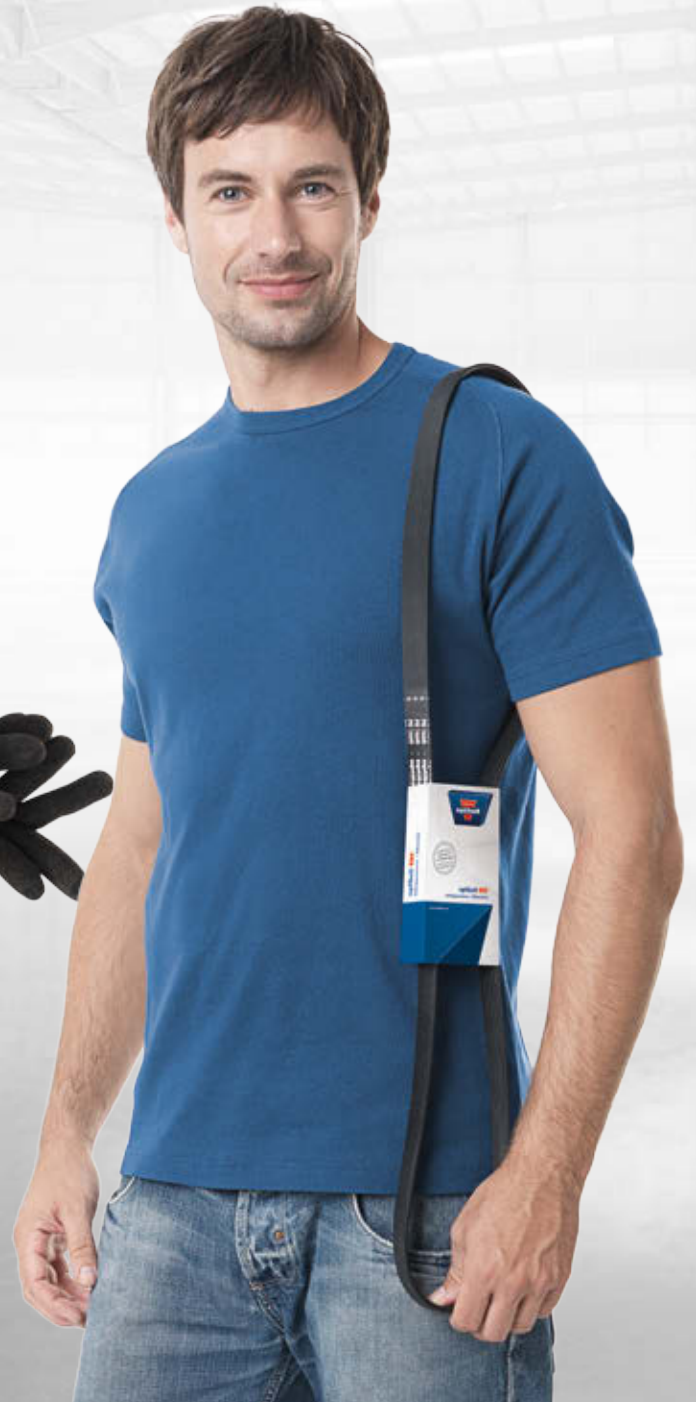

“It’s a matter
of trust.”

Paul, 46, Chief Engineer

“Because the quality
is the best.”

David, 50, Buyer



V-BELTS AND KRAFTBANDS



Page 8, 11

optibelt RED POWER 3 S=C Plus
HIGH PERFORMANCE WEDGE BELTS
AND HIGH PERFORMANCE V-BELTS
maintenance-free

optibelt KB RED POWER 3
HIGH PERFORMANCE KRAFTBANDS
maintenance-free



Page 9, 12

optibelt BLUE POWER
HIGH PERFORMANCE
WEDGE BELTS
with aramid cord

optibelt KB BLUE POWER
HIGH PERFORMANCE KRAFTBANDS
with aramid cord



Page 10, 13

optibelt SK S=C Plus
HIGH PERFORMANCE
WEDGE BELTS wrapped

optibelt VB S=C Plus
CLASSIC V-BELTS wrapped

optibelt KB/SK
KRAFTBANDS wrapped

optibelt KB/VB
KRAFTBANDS wrapped



Page 16, 17

optibelt SUPER E-POWER
HIGH PERFORMANCE
WEDGE BELTS
raw edge and moulded cogged

optibelt SUPER X-POWER
HIGH PERFORMANCE
WEDGE BELTS
raw edge and moulded cogged

optibelt SUPER TX
CLASSIC V-BELTS
raw edge and moulded cogged

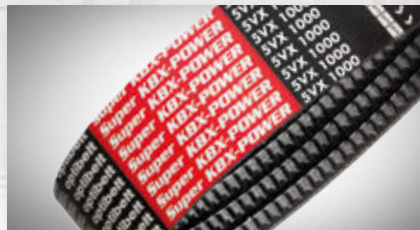

Page 17, 18

optibelt SUPER KBX-POWER
HIGH PERFORMANCE KRAFTBANDS
raw edge, moulded cogged

optibelt KBX
KRAFTBANDS
raw edge, moulded cogged



Page 18

optibelt VARIO POWER
VARIABLE SPEED BELTS
raw edge, moulded cogged

Also available as
double-sided belts

CHLOROPRENE TIMING BELTS



Page 20

optibelt OMEGA HP
HIGH PERFORMANCE TIMING BELTS
maintenance-free

optibelt OMEGA HL
HIGH PERFORMANCE TIMING BELTS
maintenance-free



Page 21

optibelt OMEGA
TIMING BELTS
powerful and universal
maintenance-free

optibelt
OMEGA FAN POWER
HIGH PERFORMANCE TIMING BELTS
maintenance-free



Page 22–23

optibelt HTD
TIMING BELTS

optibelt STD
TIMING BELTS

optibelt ZR
TIMING BELTS

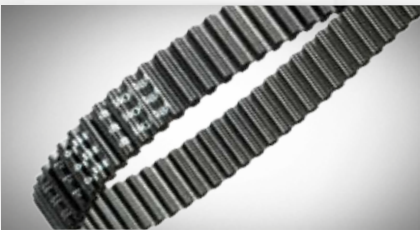

Page 23–24

optibelt OMEGA
Double-sided
TIMING BELTS

optibelt HTD
Double-sided
TIMING BELTS



Page 24

optibelt STD
Double-sided
TIMING BELTS

optibelt ZR
Double-sided
TIMING BELTS



Page 25–26

optibelt OMEGA HP LINEAR
optibelt OMEGA LINEAR
optibelt HTD LINEAR
optibelt ZR LINEAR
OPEN-ENDED TIMING BELTS
maintenance-free

POLYURETHANE TIMING BELTS



Page 34

optibelt DELTA CHAIN Carbon
HIGH PERFORMANCE TIMING BELTS

optibelt ALPHA POWER
TIMING BELTS

metric, inch and double-sided



Page 35

optibelt ALPHA TORQUE
TIMING BELTS

metric, inch and double-sided

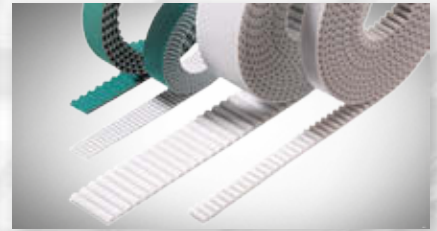

Page 36

optibelt ALPHA FLEX
TIMING BELTS

endless

optibelt ALPHA LINEAR/V
TIMING BELTS by the metre (linear),
welded endless or as flat belts



Page 37 – 38

optibelt ALPHA SPECIAL
SPECIAL TIMING BELTS

for transport

- with cleats
- with coatings
- with mechanical working

optibelt ALPHA SPECIAL
customized solutions



Page 39

optibelt ALPHA SRP
SPECIAL POLYURETHANE BELTS

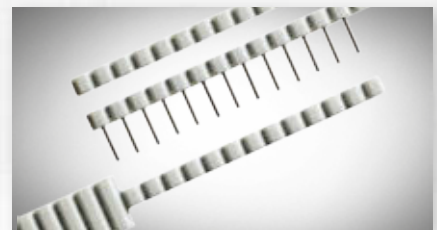

Page 40

optibelt ALPHA ZS/ZSI
TIMING BELT LOCK

optibelt PINJOIN
TIMING BELT LOCK

V-BELTS, RIBBED BELTS, TIMING BELTS AND ELASTOMER FOILS



Page 42–45

optibelt CAR POWER
optibelt TRUCK POWER
 AUTOMOTIVE DRIVE BELTS
 for cars and commercial vehicles



Page 50

optibelt RB
 RIBBED BELTS
optibelt RB
 ELASTIC RIBBED BELTS
 maintenance-free



Page 51

optibelt DK
 DOUBLE V-BELTS
optibelt RR/RR Plus/KK
 PLASTIC BELTS
 PLASTIC V-BELTS



Page 52

optibelt
OPTIMAT OE/DK/FK
 OPEN-ENDED V-BELTS
optibelt OPTIMAT PKR
 OPEN-ENDED V-BELTS
 with top surface



Page 54

optibelt ELASTOMIT
 TECHNICAL
 ELASTOMER SHEETING
optibelt ELASTOMIT
 X-RAY PROTECTION



Page 55

**FITNESS AND
 THERAPY BANDS**



Page 58–61
**PULLEYS AND BUSHES
 RANGE**



From Page 64
SERVICE TOOLS
**PROFESSIONAL TOOLS
 FOR INSTALLATION
 AND MAINTENANCE**

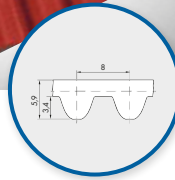

optibelt DELTA CHAIN Carbon

HIGH PERFORMANCE TIMING BELTS

DIMENSIONS

8MDC
Dimensions on request

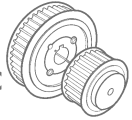
TIMING BELT PULLEYS DC 

all standard pulleys,
special pulleys on request

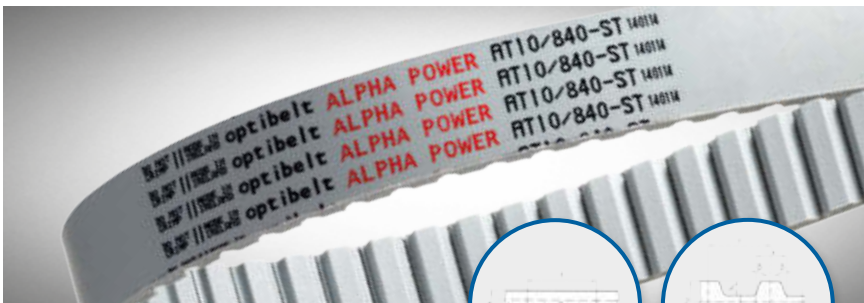

optibelt ALPHA POWER

TIMING BELTS
metric, inch and double-sided

DIMENSIONS

TIMING BELTS METRIC	
T2,5	120–950 mm
T5	165–1440 mm
T10	260–2250 mm
AT5	225–1500 mm
AT10	500–1940 mm
DOUBLE-SIDED TIMING BELTS	
DT5	300–1100 mm
DT10	260–1880 mm
Further sizes upon request	

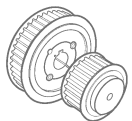
TIMING BELT PULLEYS 

all standard pulleys,
special pulleys on request



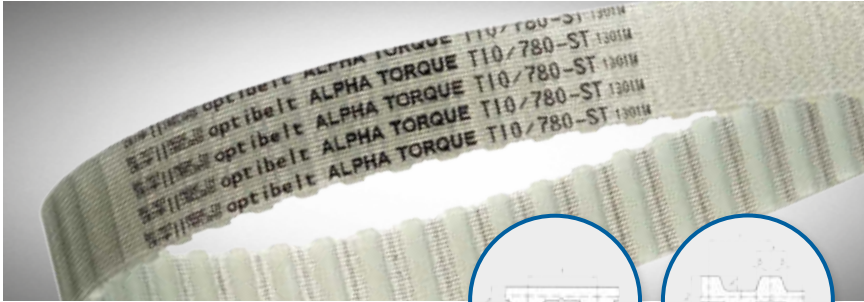

optibelt ALPHA TORQUE

TIMING BELTS

metric, inch and double-sided



DIMENSIONS	
TIMING BELTS METRIC	
T2,5	120–950 mm
T5	165–1440 mm
T10	260–2250 mm
AT5	225–1500 mm
AT10	500–1940 mm
MXL	2.40–32.00 inches
XL	6.00–67.00 inches
L	12.38–60.00 inches
DOUBLE-SIDED TIMING BELTS	
DT5	300–1100 mm
DT10	260–1880 mm
Further sizes upon request	

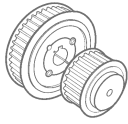

TIMING BELT PULLEYS
all standard pulleys,
special pulleys on request



optibelt ALPHA FLEX

TIMING BELTS
endless

DIMENSIONS	
T5	1500–24 000 mm
T10	1500–24 000 mm
T20	1500–24 000 mm
AT5	1500–24 000 mm
AT10	1500–24 000 mm
AT20	1500–24 000 mm
5M	1500–24 000 mm
8M	1504–24 000 mm
14M	1512–24 000 mm

Lengths > 24 000 mm upon request

TIMING BELT PULLEYS
all standard pulleys,
special pulleys on request

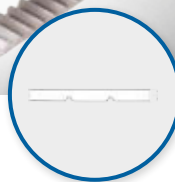

optibelt ALPHA LINEAR/V

TIMING BELTS
by the metre (linear), welded endless or as flat belts

DIMENSIONS	
LINEAR TIMING BELTS	
XL, L, H, XH	
5M, 8M, 14M	
T5, T10, T20	
AT5, AT10, AT20	
FLAT BELTS	
F2	
F3	
Standard roll length 50 m	

TIMING BELT PULLEYS
all standard pulleys,
special pulleys on request





optibelt ALPHA SPECIAL

TIMING BELTS

with cleats (welded or screwed)

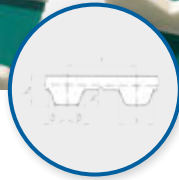

DIMENSIONS

Sections and dimensions available on request

TIMING BELT PULLEYS
all standard pulleys,
special pulleys on request



optibelt ALPHA SPECIAL

TIMING BELTS

with coatings (rear)



DIMENSIONS

Sections and dimensions available on request

TIMING BELT PULLEYS
all standard pulleys,
special pulleys on request



optibelt ALPHA SPECIAL

TIMING BELTS

with mechanical working (punching, machining, and sanding)

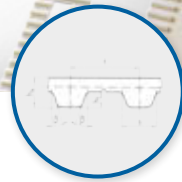

DIMENSIONS

Sections and dimensions available on request

TIMING BELT PULLEYS
all standard pulleys,
special pulleys on request

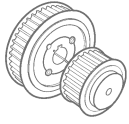
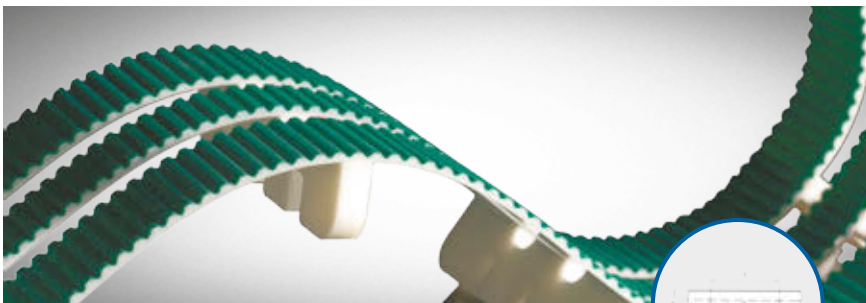
optibelt ALPHA SPECIAL

TIMING BELTS

customized solutions

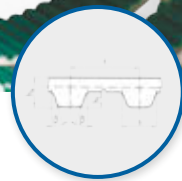

DIMENSIONS

Sections and dimensions available on request

TIMING BELT PULLEYS
all standard pulleys,
special pulleys on request

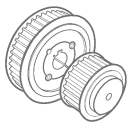

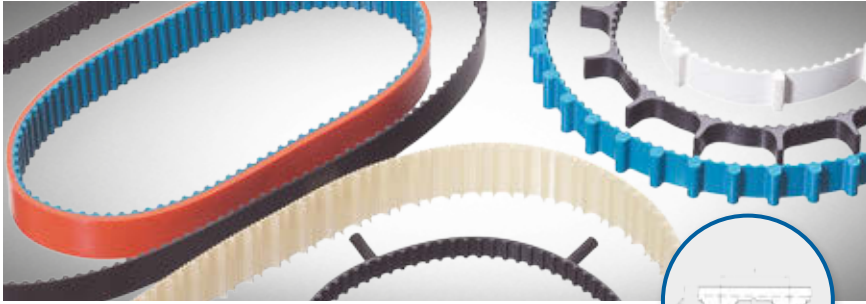
optibelt ALPHA SRP

TIMING BELTS
customized solutions

DIMENSIONS

T2.5, T5, T10, T20, AT5,
AT10, AT20, MXL, XL, L

Dimensions on request

TIMING BELT PULLEYS
all standard pulleys,
special pulleys on request

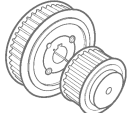

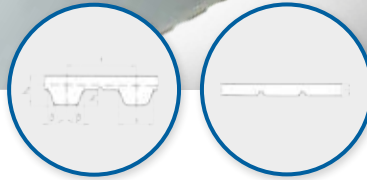
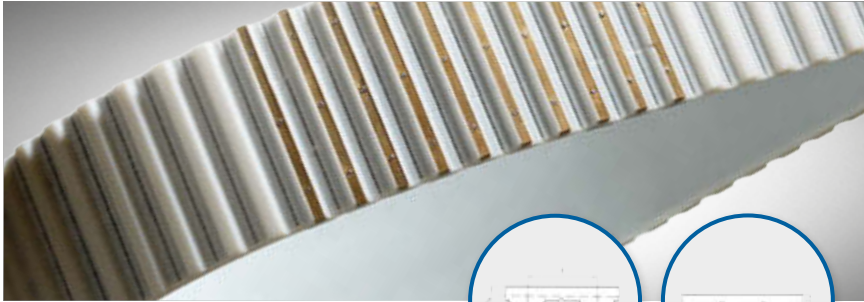

optibelt
ALPHA ZS/ZSI

TIMING BELT LOCK

DIMENSIONS

25 AT10, 32 AT10, 50 AT10
25 T10, 32 T10, 50 T10
25,4 H, 38,1 H, 50,8 H

Additional intermediate widths and widths greater than 50 mm on request

TIMING BELT PULLEYS

all standard pulleys,
special pulleys on request

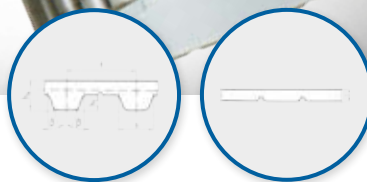
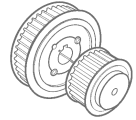

optibelt
ALPHA PINJOIN

TIMING BELT LOCK

DIMENSIONS

25 AT10, 32 AT10, 50 AT10

Additional profiles, intermediate widths and widths greater than 50 mm on request

TIMING BELT PULLEYS

all standard pulleys,
special pulleys on request



Page 42

optibelt MARATHON 1 V-BELTS

optibelt RBK RIBBED BELTS

Page 43

optibelt ZRK TIMING BELTS

optibelt KIT REPAIR SETS

Page 44

optibelt TRUCK POWER MARATHON 2 V-BELTS

optibelt TRUCK POWER RBK RIBBED BELTS

Page 45

optibelt TRUCK POWER KBX KRAFTBANDS

optibelt TRUCK POWER KIT REPAIR SETS

SERVICE TOOLS

Page 46

optibelt TT-A TENSION MEASURING DEVICE

optibelt MT-A/MT-A II INSTALLATION TOOLS

Page 47

optibelt OPTIKRIK 0, I, II, III BELT TENSION MEASURING DEVICE

optibelt MEASURING GAUGE

optibelt LASER POINTER II ALIGNMENT OF BELT DRIVES

DRIVE BELTS FOR MOTOR VEHICLES

5

“So your car purrs
like a kitten.”

Michael, 33, Mechatronics Technician

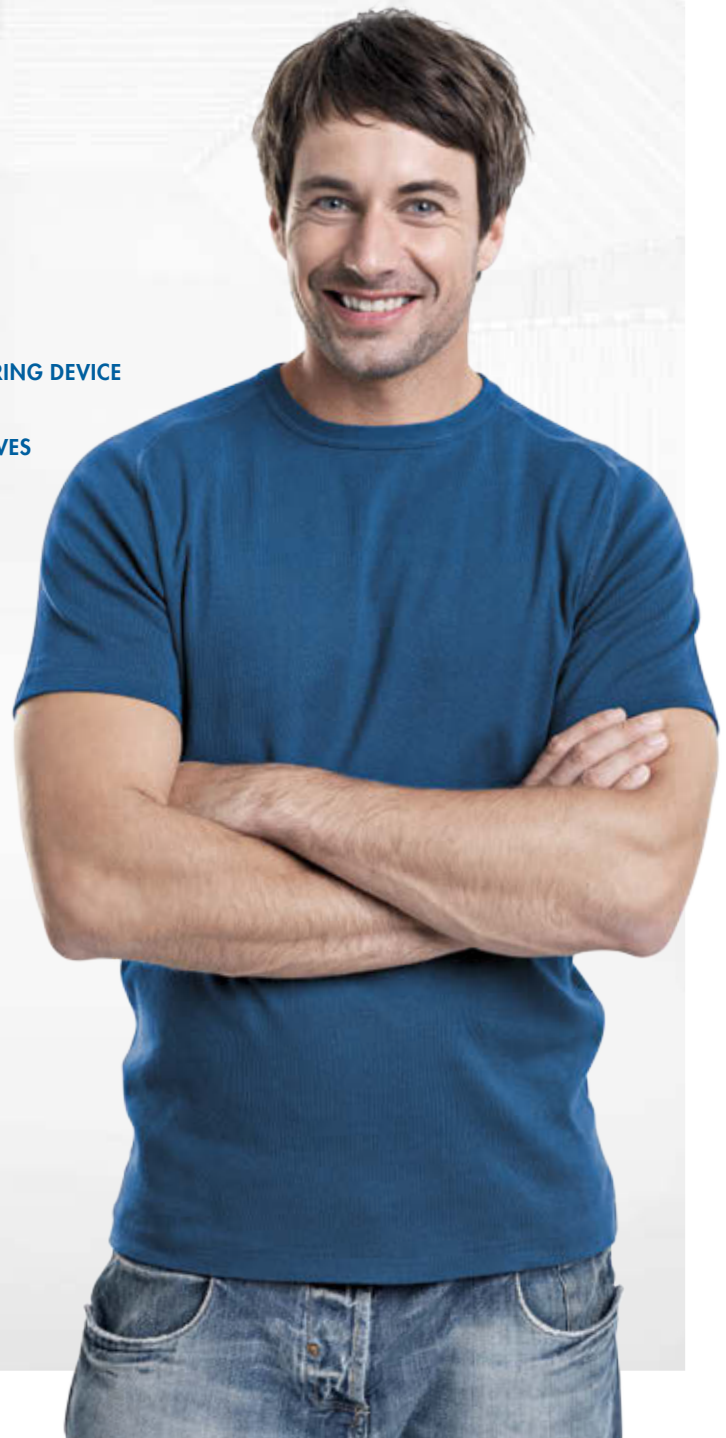



optibelt MARATHON 1

V-BELTS

raw edge, moulded cogged



SECTIONS

AVX 10, AVX 13, AVX 11,
AVX 11,2, AVX 11,5, AVX 11.9

The sections AVX 10 and AVX 13 have cross sections and dimensions compliant with DIN 7753 as well as standards ISO 2709 and SAE.

JASO E107:2000

All standard sections/lengths available

SAE J636

All standard sections/lengths available



optibelt RBK

RIBBED BELTS

standard and elastic



SECTIONS

PJ, PK, DPK, EPK

All standard sections/lengths available



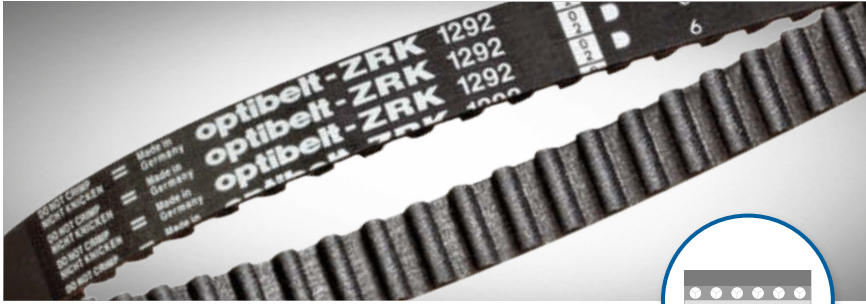

optibelt ZRK

TIMING BELTS

SECTIONS

Sections and dimensions available on request

CHOICE OF SECTIONS

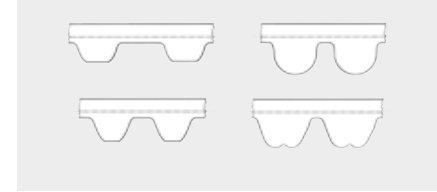

optibelt KIT

REPAIR SETS FOR VEHICLES

with and without water pumps

DIMENSIONS

Available range for all standard car models





optibelt TRUCK POWER MARATHON 2 M=S

V-BELTS

raw edge, moulded cogged, M=S usable in unmeasured sets

SECTIONS
AVX 10, AVX 13, AVP 13
All standard sections/lengths available

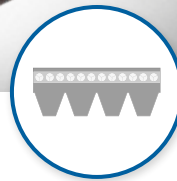

optibelt TRUCK POWER RBK

RIBBED BELTS

SECTIONS
PK
All standard sections/lengths available





optibelt TRUCK POWER KBX

KRAFTBANDS

raw edge, moulded cogged

SECTIONS
AVX 10 – 2 ribs
AVX 13 – 2 ribs
XPB – 2 ribs
All standard sections / lengths available



DIMENSIONS
Available range for all standard commercial vehicle models

optibelt TRUCK POWER KIT

REPAIR SETS FOR VEHICLES





optibelt **TT-A** Tension measuring device

FREQUENCY MEASURING DEVICE

for the universal measurement of tension
in timing belts and ribbed belts

RANGE OF MEASUREMENT

- 30–520 Hz



optibelt **MT-A**

INSTALLATION TOOLS

for the safe installation of elastic ribbed belts



optibelt **MT-A II**

INSTALLATION TOOLS

for the safe installation of elastic ribbed belts.
Special tool for Ford, Mazda and Volvo.



optibelt OPTIKRIK 0, I, II, III

BELT TENSION MEASURING DEVICE

tests reliably whether the V-belt, the kraftband or the ribbed belt has the proper tension

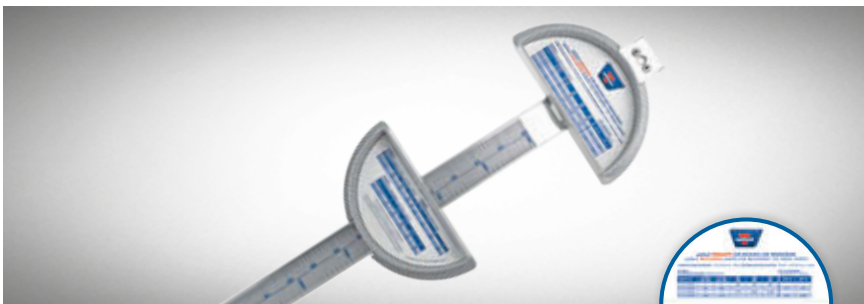

optibelt MEASURING GAUGE

for V-belts, timing belts and ribbed belts



RANGE OF MEASUREMENT

- 500–2500 mm interior length (L_i)
- 500–3500 mm interior length (L_i)



optibelt LASER POINTER II

AIDS THE ALIGNMENT OF BELT DRIVES

It also helps to determine the three most common causes of drive failures:

- the axial misalignment of the pulleys
- the horizontal angle deviation
- the vertical angle deviation

AT TOP SPEED

At Optibelt the highest quality standards come first. We are always working hard to exceed the guidelines. We have a strictly certified environmental management system and we always pay close attention to quality, the environment and safety. Making sure that our products are always the right decision.

TECDOC

**HIGH PRECISION DATA TRANSFER –
OPTIBELT IS A “TECDOC CERTIFIED DATA SUPPLIER”.**



TecDoc supplies workshops and trade with up-to-date and comprehensive data to identify and order parts for both cars and commercial vehicles. The information is provided directly from the data bases of vehicle part manufacturers in standardised catalogue form. As a particularly reliable TecDoc partner, which meets all of the necessary quality criteria in every possible aspect, Optibelt was granted the “TecDoc Certified Data Supplier” seal of approval.

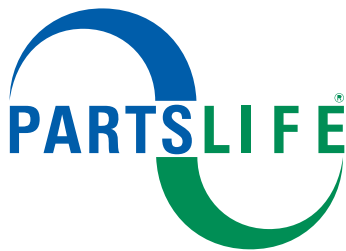

PARTSLIFE

**OPTIBELT SEES ENVIRONMENTAL PROTECTION AS
MORE THAN ADHERENCE TO LEGAL REQUIREMENTS.**

The question is: How can ecological, economical and social responsibility be brought together? Thanks to the Partslife management system developed with the automotive parts industry in mind Optibelt has a reliable environmental protection system at its side.



Page 50

optibelt RB RIBBED BELTS

optibelt RB ELASTIC RIBBED BELTS

Page 51

optibelt DK DOUBLE V-BELTS

optibelt RR/RR Plus/KK

Page 52

optibelt OPTIMAT OE/DK/FK OPEN-ENDED V-BELTS

optibelt OPTIMAT PKR OPEN-ENDED V-BELTS

BELTS FOR SPECIAL DRIVE SOLUTIONS





optibelt **RB**

RIBBED BELTS

DIMENSIONS	
PH	698–2155 mm
PJ	280–2489 mm
PK	630–2845 mm
PL	954–6096 mm
PM	2286–15 266 mm
Further sizes upon request	

RIBBED BELT PULLEYS
 standard range,
 special pulleys on request



optibelt **RB**

ELASTIC RIBBED BELTS

maintenance-free

DIMENSIONS	
EPH	700–2200 mm
EPJ	280–2500 mm
Further sizes upon request	

RIBBED BELT PULLEYS
 standard range,
 special pulleys on request



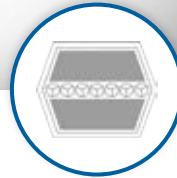
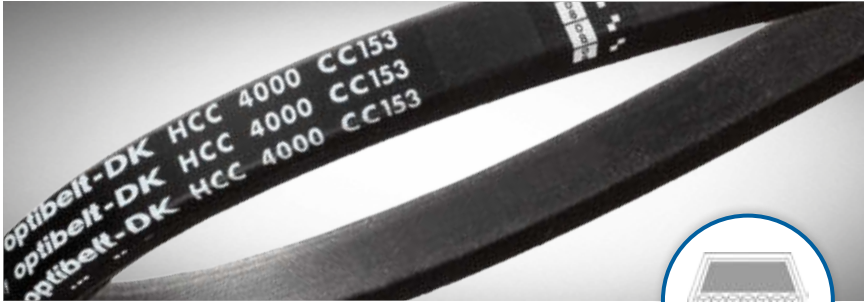

optibelt DK

DOUBLE V-BELTS
DIN 7722

DIMENSIONS	
AA/HAA	2000–3920 mm
BB/HBB	1980–5639 mm
CC/HCC	2280–5750 mm
DD/HDD	on request
22 x 22	5180–6270 mm
25 x 22	on request
Further sizes upon request	

V-GROOVED PULLEYS
all standard pulleys,
special pulleys on request

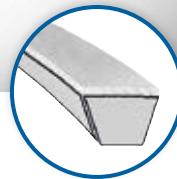

optibelt RR/RR Plus/KK

optibelt RR/RR Plus
round plastic belts without and with tension cord

optibelt KK
plastic V-belts

DIMENSIONS	
optibelt RR / RR Plus (ROLL LENGTHS)	
2 200 m	8* 100 m
3 200 m	10* 100 m
4 200 m	12* 50 m
5 200 m	15* 50 m
6* 100 m	18 30 m
7* 100 m	
optibelt KK (SECTIONS)	
8, Z/10, A/13, B/17, C/22	
* also with tension cord	

V-GROOVED PULLEYS



optibelt OPTIMAT OE/DK/FK

OPEN-ENDED V-BELTS

punched, DIN 2216

SPECIAL VERSION

- available with black chloroprene cover bands
- electrical conductance (on request)

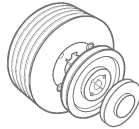

V-BELT PULLEYS
usable in DIN/ISO V-belt pulleys



OPTIMAT OE

V-belts,
DIN 2216, punched



OPTIMAT DK

double V-belts,
punched



OPTIMAT FK

conveyor belts,
punched

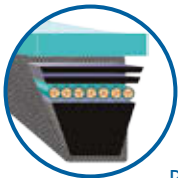

PKR 0



PKR 1

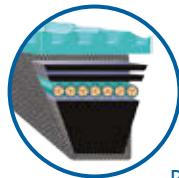

PKR 2

HEIGHT OF TOP SURFACE			
TYPE OF TOP SURFACE	STANDARD (MM)	MAX. (mm)	CLASSIFICATION (MM)
PKR 0	2	3	–
PKR 1 [♦]	3	3	10
PKR 2	3	–	–

optibelt OPTIMAT PKR

OPEN-ENDED V-BELTS

DIN 2216, with top surface

Sections: Z/10, A/13, B/17, C/22, 25*, D/32*

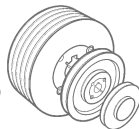

V-GROOVED PULLEYS
all standard pulleys,
special pulleys on request

*Special versions are only available for lengths greater than 50 m ± 10 %

♦For section 25 and D/32 top surface height of 5 mm is only possible

“Because the
quality is
the best.”

David, 50, Buyer

Page 54

optibelt ELASTOMIT TECHNICAL ELASTOMER SHEETING
optibelt ELASTOMIT X-RAY PROTECTION

Page 55

FITNESS AND THERAPY BANDS

TECHNICAL ELASTOMER FOILS





optibelt ELASTOMIT **TECHNICAL ELASTOMER SHEETING**

High-quality elastomer foils from Optibelt are versatile problem solvers. The products can be used in various industrial sectors, e.g. automotive, mechanical engineering, medical technology.



optibelt ELASTOMIT **X-RAY PROTECTION**

optibelt X-RAY PROTECTION offers high protection levels with low weight as well as excellent flexibility thanks to the rubber parts used. Our product range includes lead-containing, low-lead and lead-free versions.



FITNESS AND THERAPY BANDS

Optibelt is known as a reliable producer of high-quality fitness and therapy bands. Developments such as latex free fitness belts are a sign of constant innovation.



OPTIBELT SUCCESS STORY

DEUSER-BAND

Optibelt is known as a reliable producer of high-quality fitness and therapy bands: the best example is the **Original Deuser-Band**. It gets its name from the physical therapist Erich Deuser. Deuser worked with the German national football team from 1951 to 1982 and first started train the players with a bicycle tube until he developed a rubber band with variable tensions in 1967, which is specially designed for strength training: the Deuser-Band.

WELL NETWORKED

Even in digital transaction we offer our customers versatile opportunities to carry out transactions optimally and efficiently.



MEDIAPLUS

The Optibelt e-shop

Optibelt Mediaplus offers you a simple and easy opportunity for making status queries and orders via the Internet. Register at our home page www.optibelt.com and activate your access to the e-shop Mediaplus.

- **Flexibility**
Order online around the clock
- **Time savings**
Easy orientation thanks to simplified product search
- **Planning reliability**
Product availability and order status online

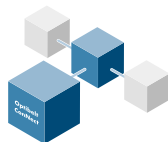

OPTIBELT CONNECT

Direct connection to our customers' procurement

With Optibelt ConNect we offer our business partners the opportunity for a direct order via the customer's procurement system as well as queries about the status of all orders.

- **Cost savings**
Single installation, quick order placement
- **Planning reliability**
Automated order and assignment confirmation
- **Time savings**
No redundant recording of order data

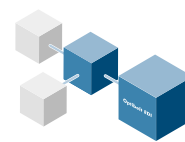

OPTIBELT EDI

The structured data exchange

Optibelt offers its business partners with EDI connection another possibility for transmitting data. EDI allows for a structured data exchange between business partners without any manual interactions, generating the error-free exchange of data.

- **Efficiency improvement**
Automated control of business processes
- **Cost avoidance**
No errors from manual data entry
- **Flexibility**
Simple platform-independent installation

Page 58

optibelt KS V-GROOVED PULLEYS

optibelt ZRS STANDARD TIMING BELT PULLEYS

Page 59

optibelt ZRS DC STANDARD TIMING BELT PULLEYS FOR **optibelt DELTA CHAIN** Carbon

optibelt RBS RIBBED BELT PULLEYS

Page 60

optibelt SPECIAL PULLEYS

optibelt METAL ACCESSORIES

Page 61

optibelt TB TAPER BUSHES

optibelt CE CLAMPING BUSHINGS

PULLEYS AND BUSHES





optibelt KS

V-GROOVED PULLEYS
in accordance with DIN 2211



Taper bushes

FOR TAPER BUSHES		
SECTION	ORIENTATION CROSS SECTION	RIBS
SPZ/10	50–630 mm	1–8
SPA/13	63–630 mm	1–5
SPB/17	100–1000 mm	1–10
SPC/22	200–1250 mm	2–10

FOR CYLINDRICAL BORES		
SECTION	ORIENTATION CROSS SECTION	RIBS
SPZ/10	45–355 mm	1–3
SPA/13	50–560 mm	1–5
SPB/17	56–630 mm	1–6
SPC/22	180–630 mm	1–6

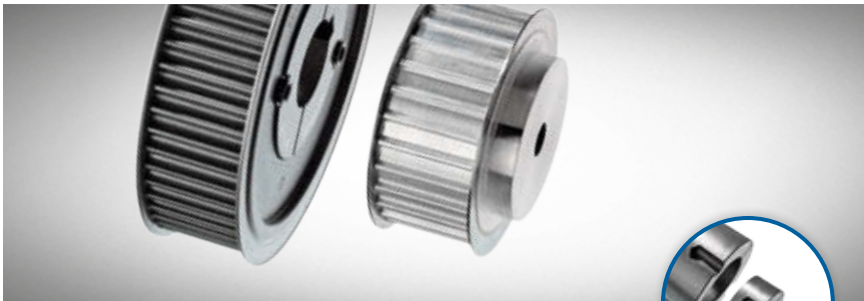

optibelt ZRS

STANDARD TIMING BELT PULLEYS



Taper bushes

FOR TAPER BUSHES		
SECTION	BELT WIDTH	TEETH
L	12.7 mm	18–120
	19.1 mm	18–120
	25.4 mm	18–120
H	25.4 mm	16–120
	38.1 mm	18–120
	50.8 mm	18–120
	76.2 mm	20–120
XH	50.8 mm	18–48
	76.2 mm	18–48
	101.6 mm	20–48

FOR CYLINDRICAL BORES		
SECTION	BELT WIDTH	TEETH
XL	6.4 mm	10–72
	7.9 mm	10–72
	9.5 mm	10–72
L	12.7 mm	10–84
	19.1 mm	10–84
	25.4 mm	10–84
H	19.1 mm	14–48
	25.4 mm	14–120
	38.1 mm	14–120
	50.8 mm	14–120
XH	76.2 mm	16–120
	50.8 mm	18–96
	76.2 mm	18–96
	101.6 mm	18–96

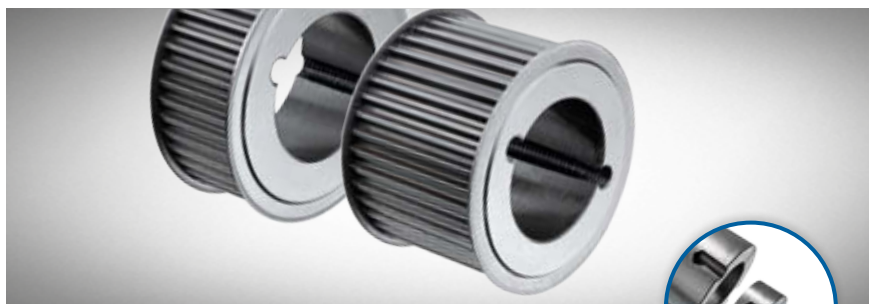

optibelt ZRS DC

STANDARD TIMING BELT PULLEYS



Taper bushes

FOR TAPER BUSHES		
SECTION	BELT WIDTH	TEETH
8MDC	12 mm	22–192
	21 mm	22–192
	36 mm	22–192
	62 mm	22–192



optibelt RBS

RIBBED BELT PULLEYS



Taper bushes

FOR TAPER BUSHES		
DESIGNATION	DIMENSIONS	RIBS
TB 4 PJ	47.5–222.5 mm	4
TB 8 PJ	47.5–222.5 mm	8
TB 12 PJ	62.5–222.5 mm	12
TB 16 PJ	62.5–222.5 mm	16
TB 6 PL	78–388 mm	6
TB 8 PL	78–388 mm	8
TB 10 PL	88–388 mm	10
TB 12 PL	88–388 mm	12
TB 16 PL	103–388 mm	16

FOR CYLINDRICAL BORES		
DESIGNATION	DIMENSIONS	RIBS
4 PJ	22.5–42.5 mm	4
8 PJ	22.5–42.5 mm	8
12 PJ	22.5–42.5 mm	12

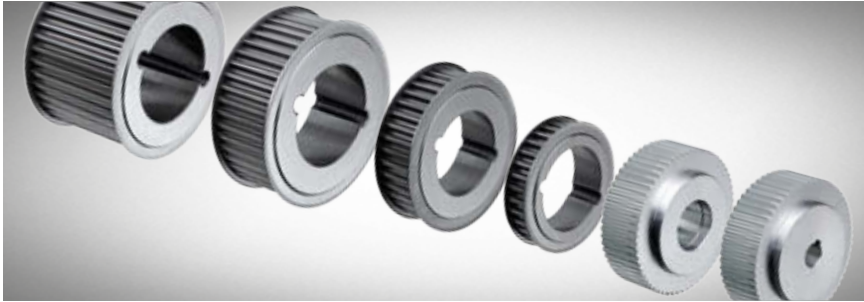

DIMENSIONS

Sections and dimensions
available on request

optibelt SPECIAL PULLEYS

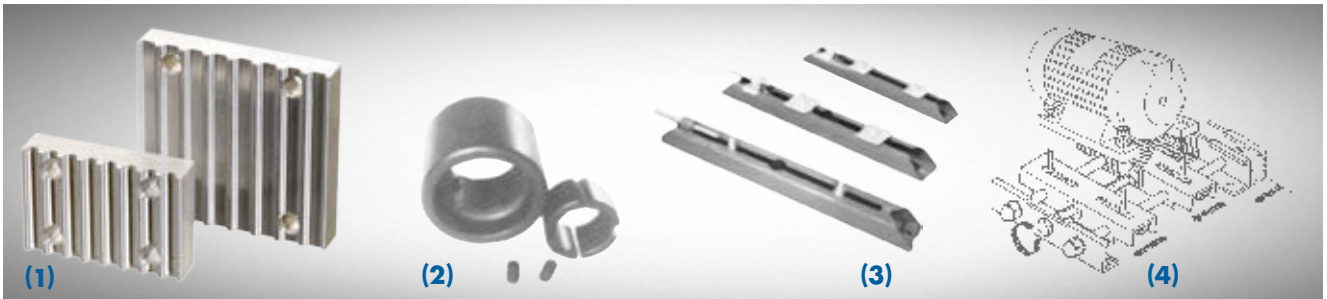

optibelt METAL ACCESSORIES

(1) optibelt CP

clamping plates

(2) optibelt FS

flat belt pulleys for taper bushes

(3) optibelt MS

motor slide rails

(4) optibelt MS

motor slides



optibelt TB

TAPER BUSHES

DIMENSIONS	
TAPER BUSHES	BORE DIAMETERS
1008	10–25 mm
1108	10–28 mm
1210	11–32 mm
1215	11–32 mm
1310	14–35 mm
1610	14–42 mm
1615	14–42 mm
2012	14–50 mm
2517	16–60 mm
3020	25–75 mm
3030	35–75 mm
3525	35–90 mm
3535	35–90 mm
4040	40–100 mm
4545	55–110 mm
5050	70–125 mm



optibelt CE

CLAMPING BUSHINGS

DIMENSIONS	
DESIGNATION	BORE DIAMETERS
CE01	18–400 mm
CE02	6–100 mm
CE03	6–150 mm
CE04	20–180 mm
CE05	20–200 mm
CE06	20–180 mm
CE07	20–200 mm
CE08	25–200 mm
CE09	45–100 mm
CE10	14–60 mm
CE11	14–60 mm
CE12	16–60 mm
CE13	15–70 mm
CE14	24–260 mm

OPTIBELT IN THE WEB

Fresh, dynamic and easy to use, optibelt.com will provide you with all you need to know about the company, the products and the services. Our industry finder will also direct you immediately to the information you need for your sector.

“There for me
around the clock.”

Michael, 33, Mechatronics Technician



Visit us at
optibelt.com

OPTIBELT SMARTPHONE APP

The Optibelt app keeps you well informed any time, anywhere. Whether you need information about the company, newsletter, order query, length and frequency calculations, the Optibelt app keeps you up to date. And with a simple click you are in the Optibelt e-shop Mediaplus and will be able to access prices and stock as well as order directly online.



iOS

Page 64

optibelt CAD DRIVE CALCULATION PROGRAM

optibelt CAP MULTI-PULLEY RANGE TIMING BELTS

Page 65

optibelt CUT II SLEEVE CUTTING MACHINE

optibelt MEASURING GAUGE FOR V-BELTS, TIMING BELTS AND RIBBED BELTS

optibelt TT OPTICAL FREQUENCY MEASURING DEVICE

Page 66

optibelt SERVICE KIT

optibelt TT MINI S FREQUENCY MEASURING GAUGE WITH FLEXIBLE NECK

optibelt LASER POINTER II ALIGNING BELT DRIVES

Page 67

optibelt TENSION NOTEBOX STICKER

optibelt SERVICE-BOX SUPPORTS MANY APPLICATIONS

SERVICE TOOLS



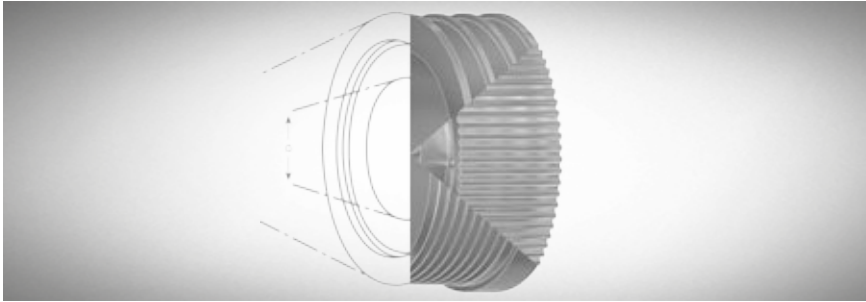

optibelt CAD

DRIVE CALCULATION PROGRAM

Download CAD files for the standard product range of pulleys and bushes in 2D and 3D models



optibelt CAP

MULTI-PULLEY RANGE TIMING BELTS

for the calculation and design of multi-pulley timing belt drives



optibelt **CUT II**

SLEEVE CUTTING MACHINE

for all standard timing belts and ribbed belts



optibelt **MEASURING GAUGE**

for V-belts, timing belts and ribbed belts

RANGE OF MEASUREMENT

- 500–2500 mm interior length (L_i)
- 500–3500 mm interior length (L_i)



optibelt **TT OPTICAL**

FREQUENCY MEASURING DEVICE

RANGE OF MEASUREMENT

- 5–500 Hz



optibelt **SERVICE KIT**

SERVICE CASE

contains a number of technical devices that can be used to carry out a series of optimisations on existing drives



optibelt **TT MINI S**

WITH FLEXIBLE NECK

for easy measurements on tough to access positions



optibelt **LASER POINTER II**

LASER ALIGNING BELT DRIVES

It also helps to determine the three most common causes of drive failures:

- the axial misalignment of the pulleys
- the horizontal angle deviation
- the vertical angle deviation



optibelt **TENSION NOTEBOX**

TENSION NOTES

The proven OPTIBELT Tension Notes sticker documents the default values for the proper tension methods.



optibelt **SERVICE-BOX**

THE ON-SITE SUPPORT FOR NUMEROUS AREAS

The tensioning of the belt and monitoring of the tension with OPTIKRIK makes it easier for installers to carry out maintenance work on site and increase the reliability of the drive.

NOTES



Maintenance-free



optibelt OMEGA timing belts run in standard HTD and RPP pulleys



S=C Plus, unmeasured set always, consistent to nominal mass



Includes ribbed V-belts, ribbed belts and toothed pulleys



97 % efficiency



Large selection for motor vehicles



M=S Matched Sets, unmeasured use in sets



Large selection for trucks and buses

SPECIAL SOLUTIONS



FDA conform for food production



LC
V-belts with covering weave



EL
Electrically conductive V-belts



LD
Light Duty V-belts in accordance with US Standard RMA/MPTA



Mining
Optibelt V-belts, used in underground mining



With coatings,
individual customer solutions



HVAC S=C Plus
Classic V-belts for heat, ventilation and air-conditioning drives

Reproduction prohibited, violations will be prosecuted as a copyright offence. Errors and omissions excepted. Optibelt products are exclusively for wholesalers, Optibelt only recommends the use of its products as instructed in the Optibelt documentation. The use of Optibelt drive belts in aeroplanes or aviation-like systems is prohibited due to safety reasons. Optibelt denies all liability for its products if used in applications they were not designed or manufactured for. For all other matters, Optibelt refers you to its general terms and conditions.

The currently valid conditions can be found at www.optibelt.com

Optibelt GmbH

Corveyer Allee 15
37671 Hörter
GERMANY

T +49 (0) 5271-621

F +49 (0) 5271-976200

E info@optibelt.com



www.optibelt.com